

# DATA SHEET

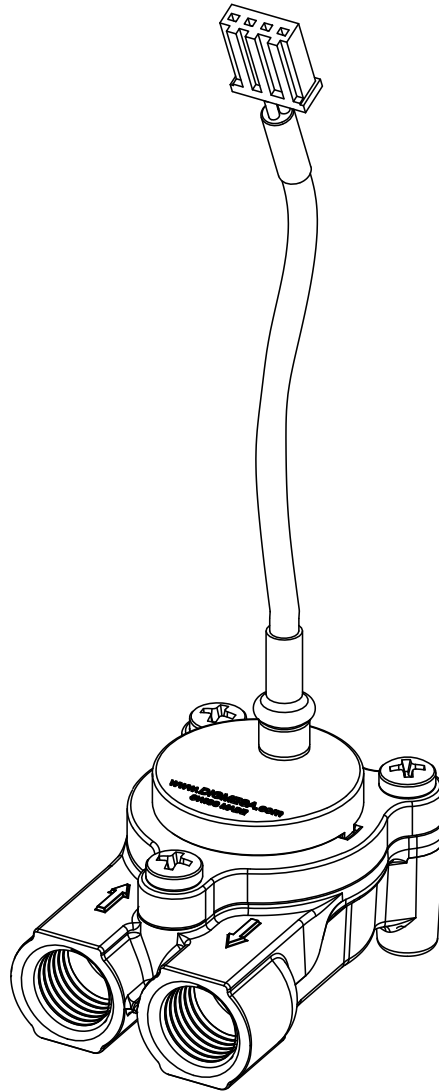

**DIGIMESA**<sup>+</sup>  
CHOOSE THE ORIGINAL

---

FH AMP G1/4" Flat  
Part number: 93A-06xx/xV04

Digimesa AG, Keltenstrasse 31, CH-2563 Ipsach / Switzerland  
Phone +41 (32) 332 77 77, Fax +41 (32) 332 77 88

[www.digimesa.com](http://www.digimesa.com)

Version 03 FH AMP G1/4" Flach #93A-06xx/FV04 GB Page 1-11

# General Description

The FH Flowmeter is a general-purpose device; its working range can be individually defined according to its nozzle size. It is employed for measuring, regulating or metering and guarantees most precise measurement of fluid quantities. In addition, a pulse generator integrated into the flowmeter guarantees a practically unlimited useful life.

**Specific applications:** Inlet and outlet on the same side, compact design, great working range, depending on the nozzle diameter.

## Approvals / Standards

EN55014-1:00+A1:01+A2:02, EN61000-6-3:01+A11:04, IEC61000-6-3:06(ed.2.0), EN61000-3-2:06, IEC61000-3-2:05(ed.3.0), EN61000-3-3:95+A1:01+A2:05, IEC61000-3-3:94+A1:01+A2:05(Cons.ed 1.2), EN55014-2:97+A1:01, EN61000-6-1:01, IEC61000-6-1:05(ed.2)



## Material:

Housing: Lower section special lead-free brass  
Upper section PA  
Bearing pin: Inox 1.4305 (18/8)  
Nozzle: Ø 1.0, 1.14, 1.2, 2.0, 2.5mm PPS 40%GF  
Nozzle: Ø 3.0, 4.0mm Inox 1.4305  
Nozzle: Ø 6.0mm like housing  
O-ring: FPM (Viton)  
Turbine: PVDF  
Magnets: Ceramic Sr Fe O (not in contact with the medium)  
Srew: Inox A2 pan head screws (Phillips cross recessed)

## Technical data:

Flow rate: 0.038 - 11.55 V/min depending on the nozzle diameter  
Continuous operation: Turbine max. 500 rpm  
Measuring accuracy: +/- 2.0%  
Repetition: < +/- 0.25%  
Temperature range: -10°C to +100°C  
14°F to 212°F  
Pressure range: 20 bar at 20°C  
290 psi / 68°F  
Mounting position: Horizontal \*  
Nozzle size: Ø 1.0, 1.14, 1.2, 2.0, 2.5, 3.0, 4.0, 6.0mm

## Electrical connection ratings:

Power supply: +3.8 to +24 VDC  
Consumption: < 8 mA  
Signal connection: Open collector NPN  
Signal voltage: 0 VDC GND (saturation < 0.7 V)  
Signal load: max. 20 mA  
Leakage current: max. 10 µA  
Connections: Cable 3 pin to 105°C / 221°F, Plug CSC B 5041  
Signal: Square-wave output  
Duty Cycle: ~ 50%

## Dimensions in mm:

\* Horizontal position is, when this side is facing up.

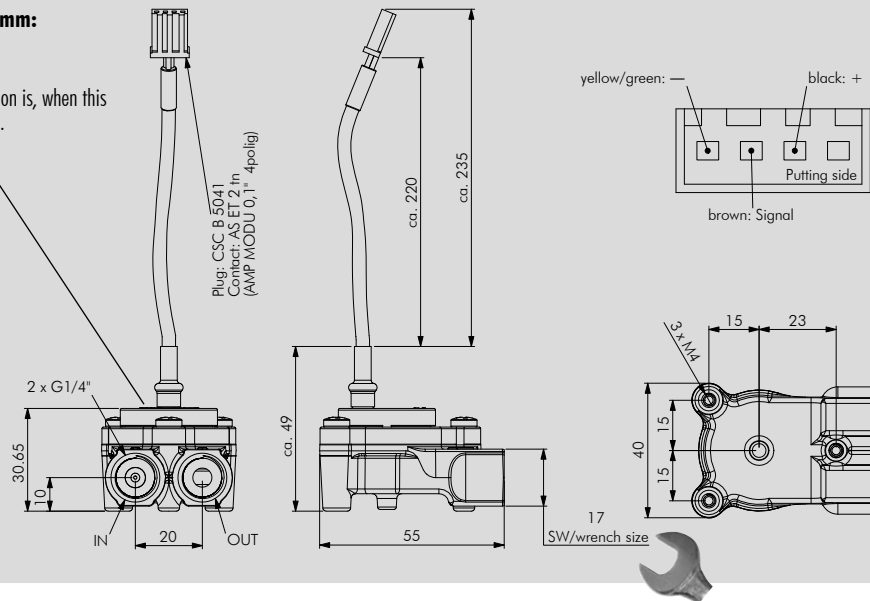

## RESISTANCE

Special regulations which must be complied with by the flowmeter manufacturer apply to each country, e.g. CE, NSF, FDA and SK. The various media flowing through the flowmeter differ from application to application. You are advised to enquire with the medium manufacturer as to whether the entire installation and the flowmeter are resistant to the medium itself (see Material)!

## ELECTRONIC

DIGMESA electronic circuitry is always designed for operation with DIGMESA flowmeters. Please note the following if connecting to other electronic circuitry:

- The flowmeter does not supply an output voltage but switches the signal terminal to 0 V ground (actuated) or leaves it open (non-actuated)
- There must be a pull-up resistor between power supply + and signal depending on electronic circuitry!

# Interface Connection: Examples Open Collector

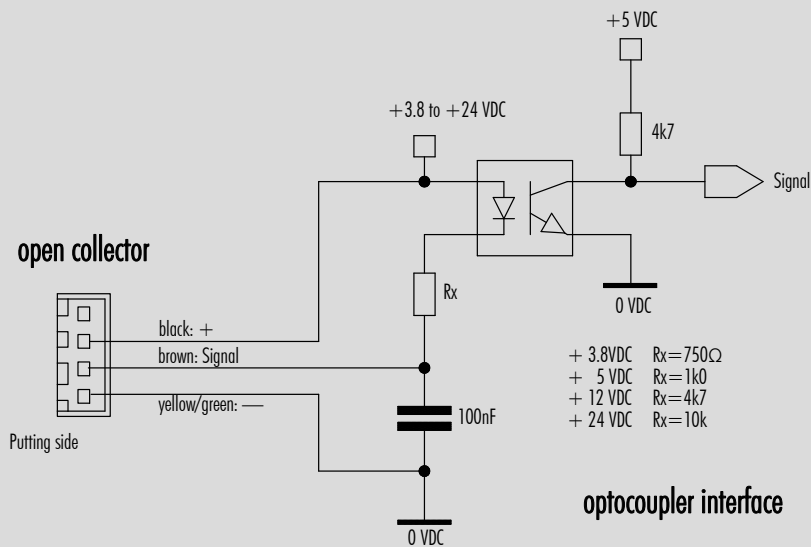
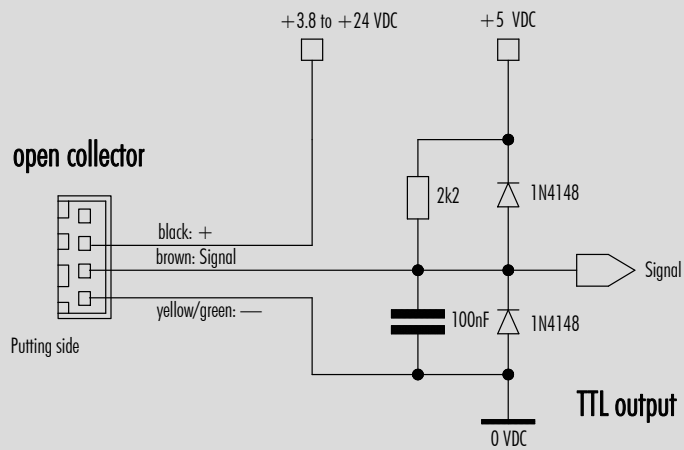
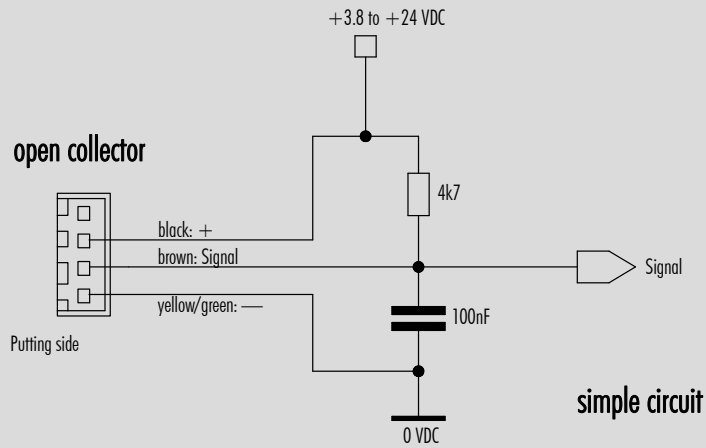

# Measurement Curve FH 1.00 mm (#93A-0610/FV04)

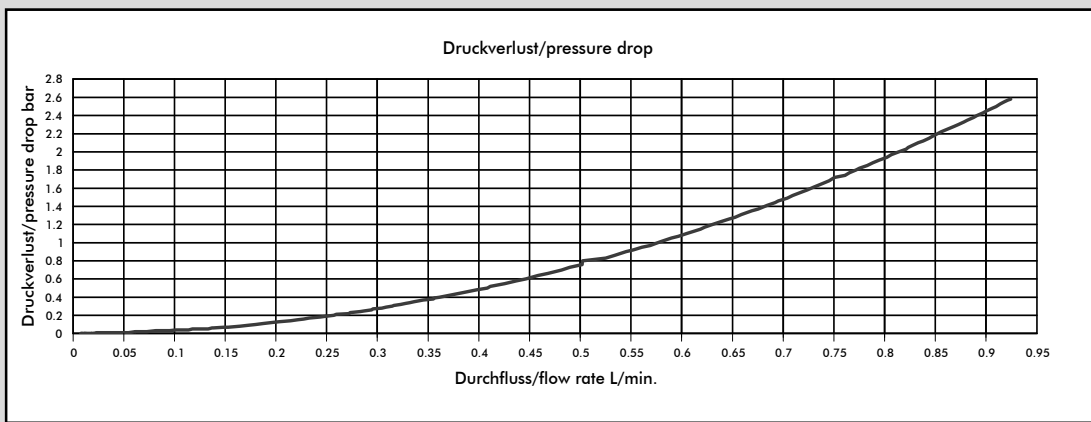
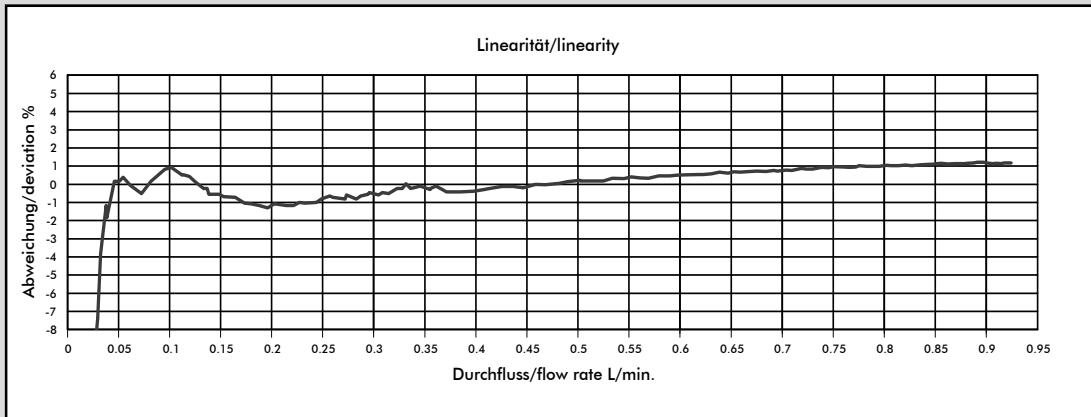

Medium: Water / max. Pressure: 3.3 bar

| Nozzle size | Pulses/litre | g/pulse | min. flow rate in [litres/min] at linear start | max. flow rate in [litres/min] | Pressure loss in [bar] |
|-------------|--------------|---------|--|--------------------------------|------------------------|
| Ø 1.00 mm   | 2219         | 0.45    | 0.038  | 0.58                           | 1.0                    |
| Ø 1.14 mm   | 2000         | 0.50    | 0.087  | 0.85                           | 1.0                    |
| Ø 1.20 mm   | 1830         | 0.54    | 0.052  | 0.80                           | 1.0                    |
| Ø 2.00 mm   | 990          | 1.01    | 0.097  | 2.32                           | 1.0                    |
| Ø 2.50 mm   | 766          | 1.30    | 0.172  | 3.78                           | 1.0                    |
| Ø 3.00 mm   | 577          | 1.73    | 0.083  | 4.66                           | 1.0                    |
| Ø 4.00 mm   | 409          | 2.44    | 0.187  | 8.30                           | 1.0                    |
| Ø 6.00 mm   | 237          | 4.20    | 0.416  | 11.55                          | 1.0                    |

## MEASUREMENT TIPS

- Ensure that there is no fast-pulsatory movement of the media
- Ensure that there are no reverse pressure surges
- Ensure that there is no air in the system
- Keep the pressure loss as small as possible
- Note the mounting position of the flowmeter
- Min/max flow should be in the linear range of the selected flowmeter
- Clean the system at appropriate intervals
- Avoid electrical current peaks
- Incorrect cabling of power supply +, signal and ground will destroy the flowmeter
- Do not mechanically load electrical contacts
- Avoid moisture on the electrical contacts
- Avoid stray pick-up via the cable (Do not lay cables in parallel with high current loads)

**The values specified must be considered as approximate values.**

**The number of pulses per litre may differ depending on medium and installation.**

**We recommend to calibrate the number of pulses per litre in line with the complete installation.**

# Measurement Curve FH 1.14 mm (#93A-06G1/FV04)

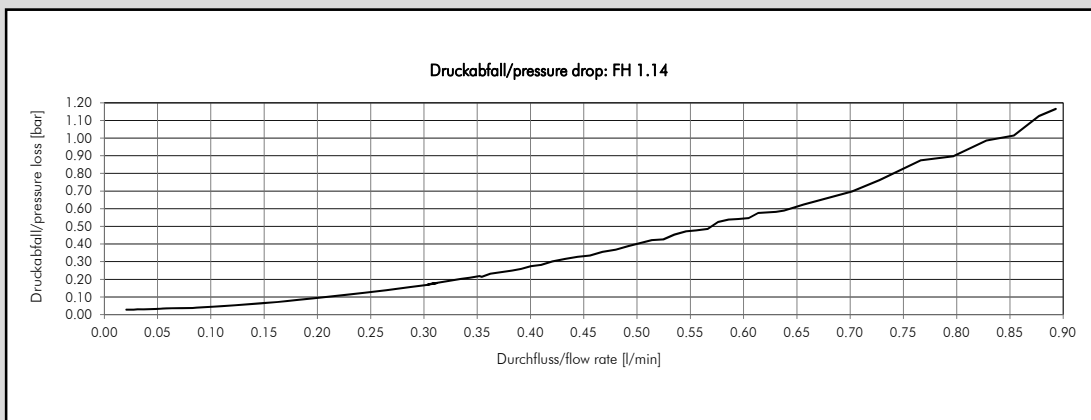
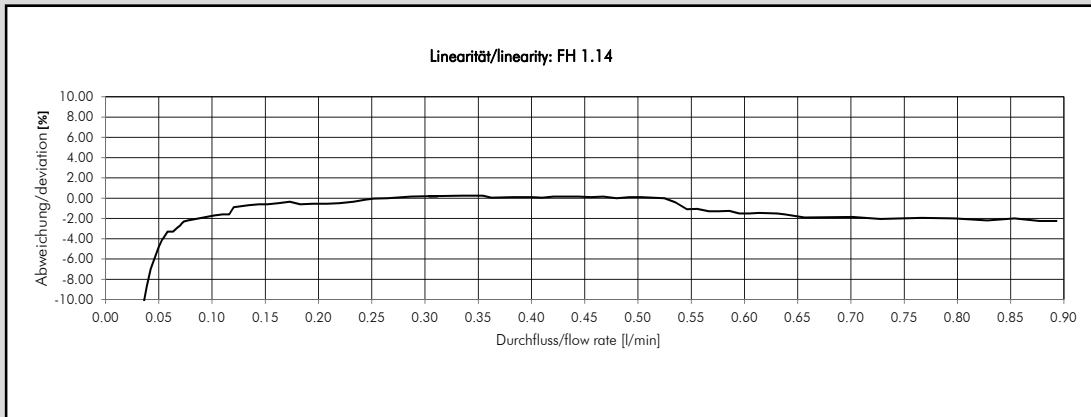

Medium: Water / max. Pressure: 3.3 bar

| Nozzle size | Pulses/litre | g/pulse | min. flow rate in [litres/min] at linear start | max. flow rate in [litres/min] | Pressure loss in [bar] |
|-------------|--------------|---------|--|--------------------------------|------------------------|
| Ø 1.00 mm   | 2219         | 0.45    | 0.038  | 0.58                           | 1.0                    |
| Ø 1.14 mm   | 2000         | 0.50    | 0.087  | 0.85                           | 1.0                    |
| Ø 1.20 mm   | 1830         | 0.54    | 0.052  | 0.80                           | 1.0                    |
| Ø 2.00 mm   | 990          | 1.01    | 0.097  | 2.32                           | 1.0                    |
| Ø 2.50 mm   | 766          | 1.30    | 0.172  | 3.78                           | 1.0                    |
| Ø 3.00 mm   | 577          | 1.73    | 0.083  | 4.66                           | 1.0                    |
| Ø 4.00 mm   | 409          | 2.44    | 0.187  | 8.30                           | 1.0                    |
| Ø 6.00 mm   | 237          | 4.20    | 0.416  | 11.55                          | 1.0                    |

## MEASUREMENT TIPS

- Ensure that there is no fast-pulsatory movement of the media
- Ensure that there are no reverse pressure surges
- Ensure that there is no air in the system
- Keep the pressure loss as small as possible
- Note the mounting position of the flowmeter
- Min/max flow should be in the linear range of the selected flowmeter
- Clean the system at appropriate intervals
- Avoid electrical current peaks
- Incorrect cabling of power supply +, signal and ground will destroy the flowmeter
- Do not mechanically load electrical contacts
- Avoid moisture on the electrical contacts
- Avoid stray pick-up via the cable (Do not lay cables in parallel with high current loads)

**The values specified must be considered as approximate values.**

**The number of pulses per litre may differ depending on medium and installation.**

**We recommend to calibrate the number of pulses per litre in line with the complete installation.**

# Measurement Curve FH 1.20 mm (#93A-0612/FV04)

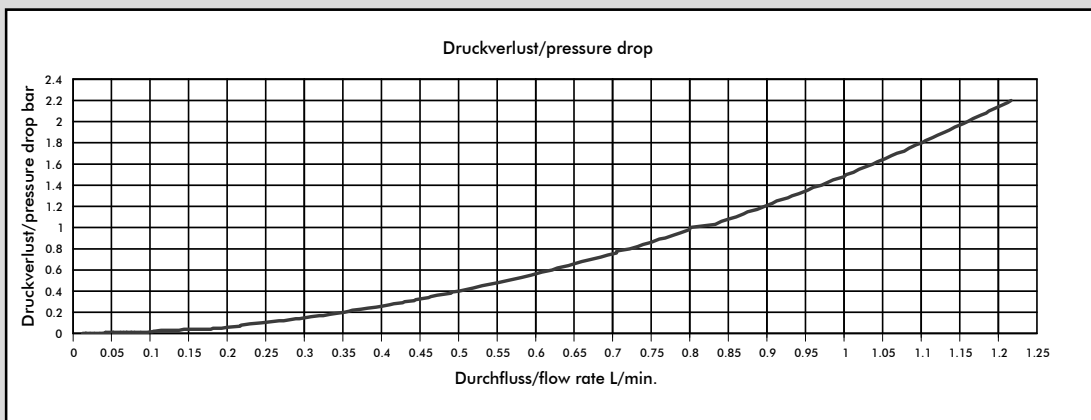
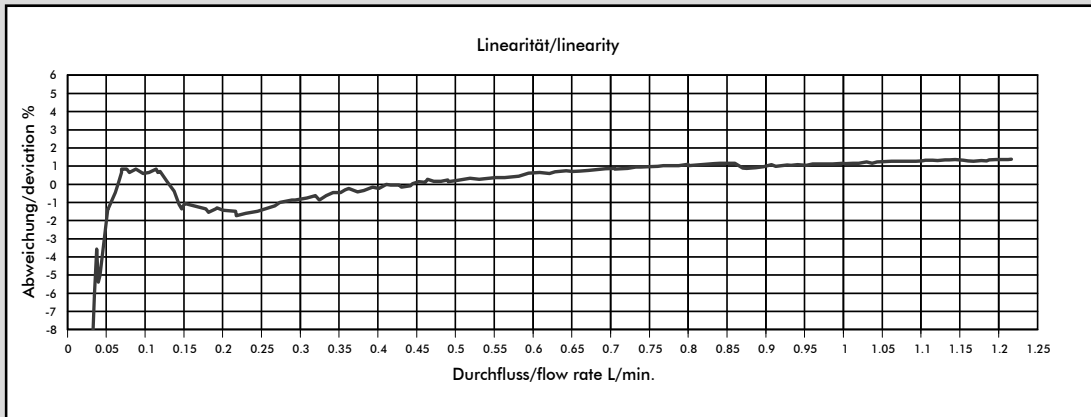

Medium: Water / max. Pressure: 3.3 bar

| Nozzle size | Pulses/litre | g/pulse | min. flow rate in [litres/min] at linear start | max. flow rate in [litres/min] | Pressure loss in [bar] |
|-------------|--------------|---------|--|--------------------------------|------------------------|
| Ø 1.00 mm   | 2219         | 0.45    | 0.038  | 0.58                           | 1.0                    |
| Ø 1.14 mm   | 2000         | 0.50    | 0.087  | 0.85                           | 1.0                    |
| Ø 1.20 mm   | 1830         | 0.54    | 0.052  | 0.80                           | 1.0                    |
| Ø 2.00 mm   | 990          | 1.01    | 0.097  | 2.32                           | 1.0                    |
| Ø 2.50 mm   | 766          | 1.30    | 0.172  | 3.78                           | 1.0                    |
| Ø 3.00 mm   | 577          | 1.73    | 0.083  | 4.66                           | 1.0                    |
| Ø 4.00 mm   | 409          | 2.44    | 0.187  | 8.30                           | 1.0                    |
| Ø 6.00 mm   | 237          | 4.20    | 0.416  | 11.55                          | 1.0                    |

## MEASUREMENT TIPS

- Ensure that there is no fast-pulsatory movement of the media
- Ensure that there are no reverse pressure surges
- Ensure that there is no air in the system
- Keep the pressure loss as small as possible
- Note the mounting position of the flowmeter
- Min/max flow should be in the linear range of the selected flowmeter
- Clean the system at appropriate intervals
- Avoid electrical current peaks
- Incorrect cabling of power supply +, signal and ground will destroy the flowmeter
- Do not mechanically load electrical contacts
- Avoid moisture on the electrical contacts
- Avoid stray pick-up via the cable (Do not lay cables in parallel with high current loads)

**The values specified must be considered as approximate values.**

**The number of pulses per litre may differ depending on medium and installation.**

**We recommend to calibrate the number of pulses per litre in line with the complete installation.**

# Measurement Curve FH 2.00 mm (#93A-0620/FV04)

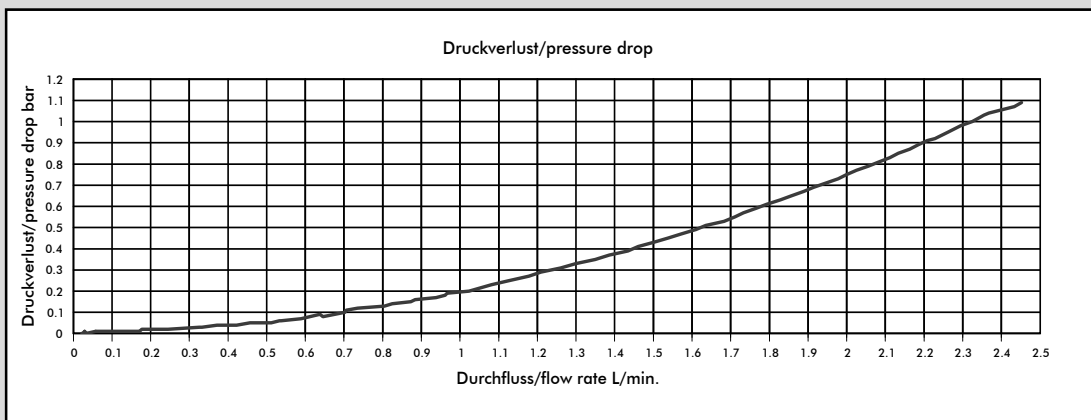
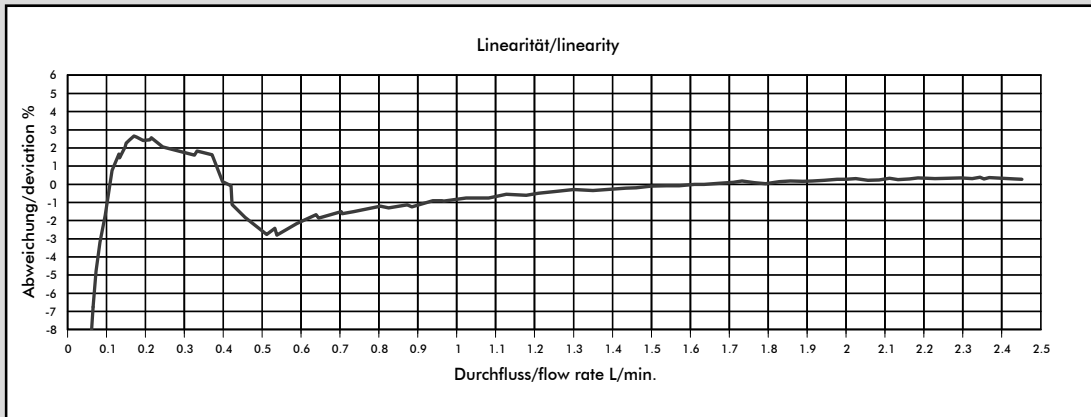

Medium: Water / max. Pressure: 3.3 bar

| Nozzle size | Pulses/litre | g/pulse | min. flow rate in [litres/min] at linear start | max. flow rate in [litres/min] | Pressure loss in [bar] |
|-------------|--------------|---------|--|--------------------------------|------------------------|
| Ø 1.00 mm   | 2219         | 0.45    | 0.038  | 0.58                           | 1.0                    |
| Ø 1.14 mm   | 2000         | 0.50    | 0.087  | 0.85                           | 1.0                    |
| Ø 1.20 mm   | 1830         | 0.54    | 0.052  | 0.80                           | 1.0                    |
| Ø 2.00 mm   | 990          | 1.01    | 0.097  | 2.32                           | 1.0                    |
| Ø 2.50 mm   | 766          | 1.30    | 0.172  | 3.78                           | 1.0                    |
| Ø 3.00 mm   | 577          | 1.73    | 0.083  | 4.66                           | 1.0                    |
| Ø 4.00 mm   | 409          | 2.44    | 0.187  | 8.30                           | 1.0                    |
| Ø 6.00 mm   | 237          | 4.20    | 0.416  | 11.55                          | 1.0                    |

## MEASUREMENT TIPS

- Ensure that there is no fast-pulsatory movement of the media
- Ensure that there are no reverse pressure surges
- Ensure that there is no air in the system
- Keep the pressure loss as small as possible
- Note the mounting position of the flowmeter
- Min/max flow should be in the linear range of the selected flowmeter
- Clean the system at appropriate intervals
- Avoid electrical current peaks
- Incorrect cabling of power supply +, signal and ground will destroy the flowmeter
- Do not mechanically load electrical contacts
- Avoid moisture on the electrical contacts
- Avoid stray pick-up via the cable (Do not lay cables in parallel with high current loads)

**The values specified must be considered as approximate values.**

**The number of pulses per litre may differ depending on medium and installation.**

**We recommend to calibrate the number of pulses per litre in line with the complete installation.**

# Measurement Curve FH 2.50 mm (#93A-0625/FV04)

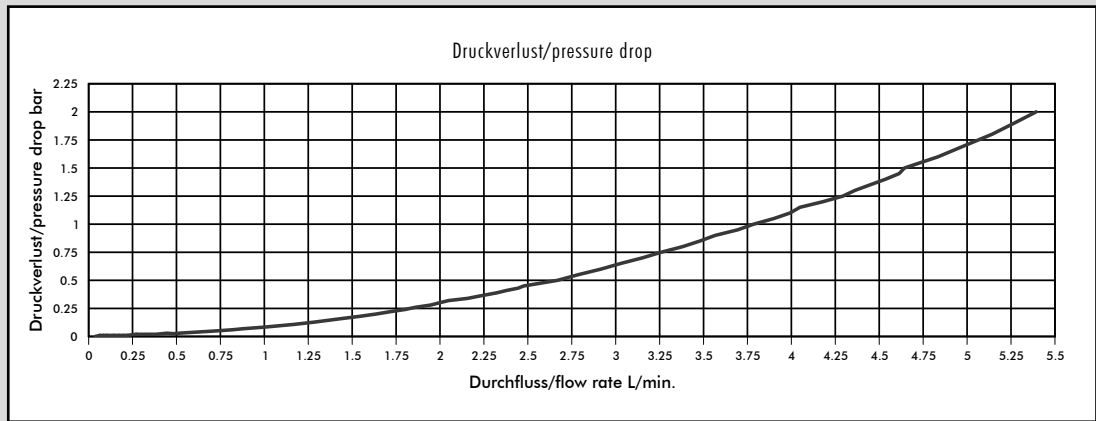
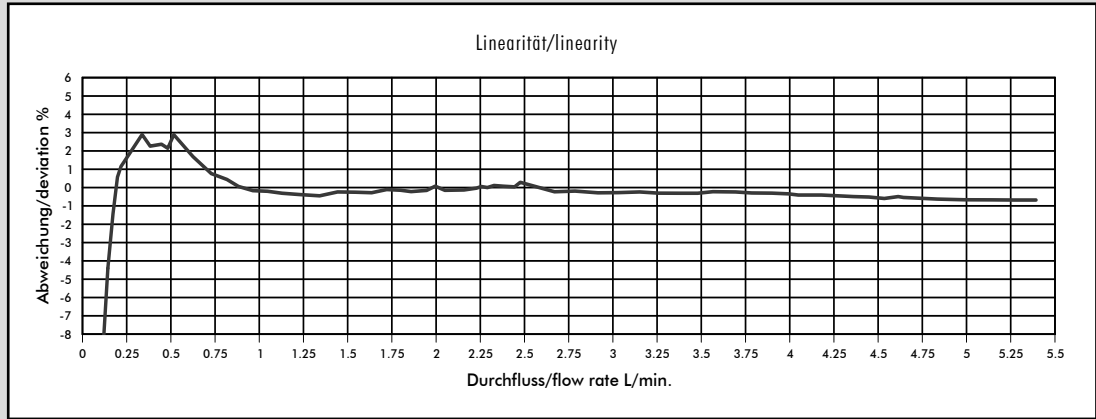

Medium: Water / max. Pressure: 3.3 bar

| Nozzle size | Pulses/litre | g/pulse | min. flow rate in [litres/min] at linear start | max. flow rate in [litres/min] | Pressure loss in [bar] |
|-------------|--------------|---------|--|--------------------------------|------------------------|
| Ø 1.00 mm   | 2219         | 0.45    | 0.038  | 0.58                           | 1.0                    |
| Ø 1.14 mm   | 2000         | 0.50    | 0.087  | 0.85                           | 1.0                    |
| Ø 1.20 mm   | 1830         | 0.54    | 0.052  | 0.80                           | 1.0                    |
| Ø 2.00 mm   | 990          | 1.01    | 0.097  | 2.32                           | 1.0                    |
| Ø 2.50 mm   | 766          | 1.30    | 0.172  | 3.78                           | 1.0                    |
| Ø 3.00 mm   | 577          | 1.73    | 0.083  | 4.66                           | 1.0                    |
| Ø 4.00 mm   | 409          | 2.44    | 0.187  | 8.30                           | 1.0                    |
| Ø 6.00 mm   | 237          | 4.20    | 0.416  | 11.55                          | 1.0                    |

**The values specified must be considered as approximate values.**

**The number of pulses per litre may differ depending on medium and installation.**

**We recommend to calibrate the number of pulses per litre in line with the complete installation.**

## MEASUREMENT TIPS

- Ensure that there is no fast-pulsatory movement of the media
- Ensure that there are no reverse pressure surges
- Ensure that there is no air in the system
- Keep the pressure loss as small as possible
- Note the mounting position of the flowmeter
- Min/max flow should be in the linear range of the selected flowmeter
- Clean the system at appropriate intervals
- Avoid electrical current peaks
- Incorrect cabling of power supply +, signal and ground will destroy the flowmeter
- Do not mechanically load electrical contacts
- Avoid moisture on the electrical contacts
- Avoid stray pick-up via the cable (Do not lay cables in parallel with high current loads)



# Measurement Curve FH Ø3.00mm (#93A-0630/V04)

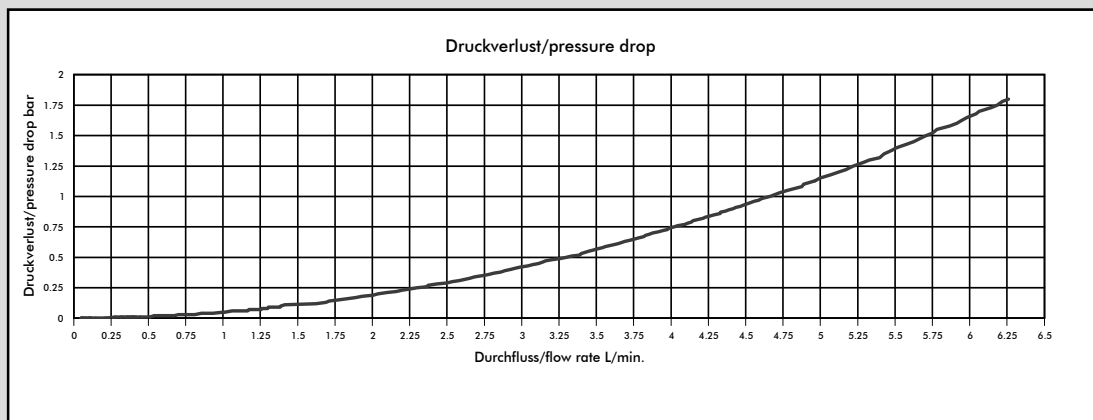
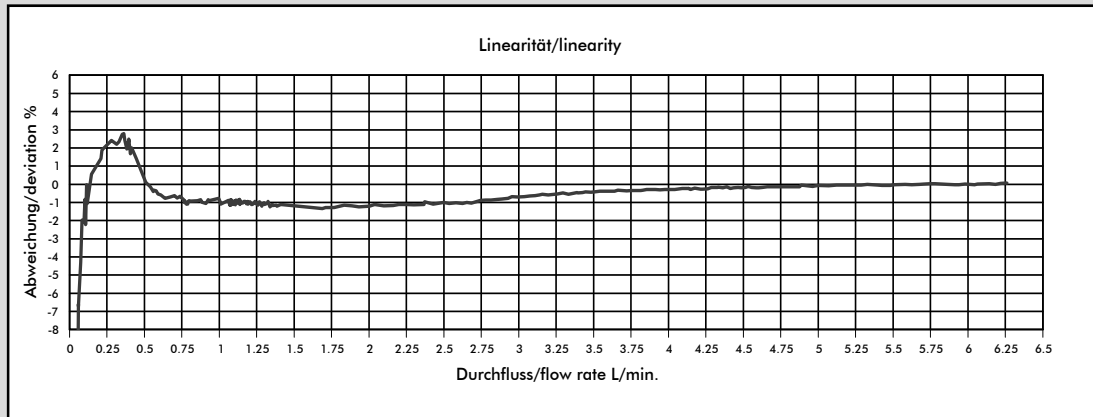

Medium: Water / max. Pressure: 3.3 bar

| Nozzle size | Pulses/litre | g/pulse | min. flow rate in [litres/min] at linear start | max. flow rate in [litres/min] | Pressure loss in [bar] |
|-------------|--------------|---------|--|--------------------------------|------------------------|
| Ø 1.00 mm   | 2219         | 0.45    | 0.038  | 0.58                           | 1.0                    |
| Ø 1.14 mm   | 2000         | 0.50    | 0.087  | 0.85                           | 1.0                    |
| Ø 1.20 mm   | 1830         | 0.54    | 0.052  | 0.80                           | 1.0                    |
| Ø 2.00 mm   | 990          | 1.01    | 0.097  | 2.32                           | 1.0                    |
| Ø 2.50 mm   | 766          | 1.30    | 0.172  | 3.78                           | 1.0                    |
| Ø 3.00 mm   | 577          | 1.73    | 0.083  | 4.66                           | 1.0                    |
| Ø 4.00 mm   | 409          | 2.44    | 0.187  | 8.30                           | 1.0                    |
| Ø 6.00 mm   | 237          | 4.20    | 0.416  | 11.55                          | 1.0                    |

## MEASUREMENT TIPS

- Ensure that there is no fast-pulsatory movement of the media
- Ensure that there are no reverse pressure surges
- Ensure that there is no air in the system
- Keep the pressure loss as small as possible
- Note the mounting position of the flowmeter
- Min/max flow should be in the linear range of the selected flowmeter
- Clean the system at appropriate intervals
- Avoid electrical current peaks
- Incorrect cabling of power supply +, signal and ground will destroy the flowmeter
- Do not mechanically load electrical contacts
- Avoid moisture on the electrical contacts
- Avoid stray pick-up via the cable (Do not lay cables in parallel with high current loads)

**The values specified must be considered as approximate values.**

**The number of pulses per litre may differ depending on medium and installation.**

**We recommend to calibrate the number of pulses per litre in line with the complete installation.**

# Measurement Curve FH Ø4.00mm (#93A-0640/V04)

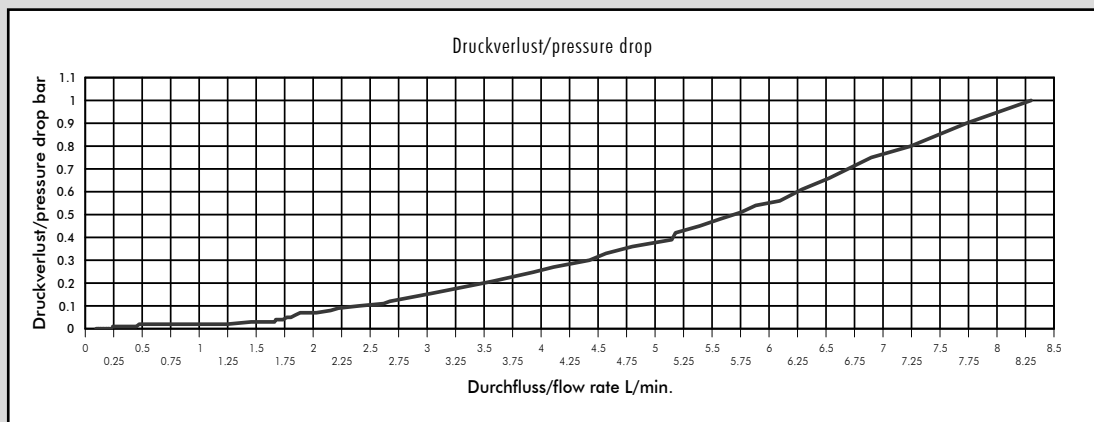
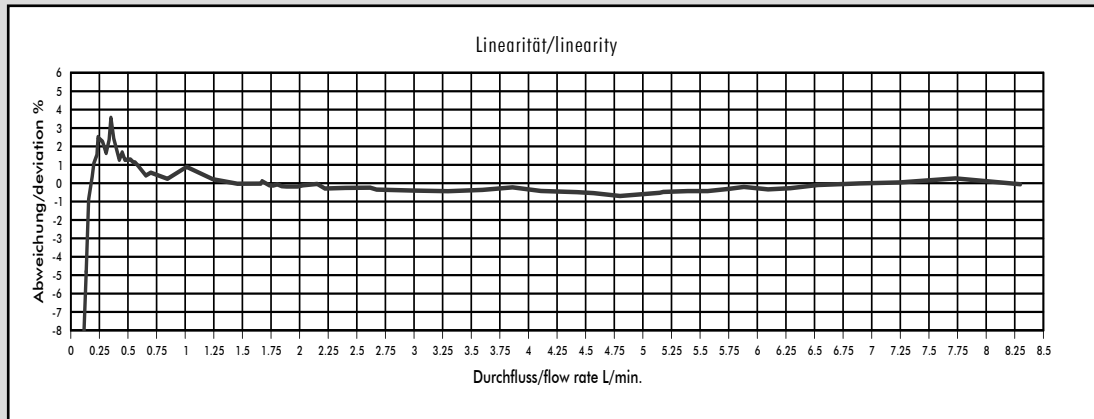

Medium: Water / max. Pressure: 3.3 bar

| Nozzle size | Pulses/litre | g/pulse | min. flow rate in [litres/min] at linear start | max. flow rate in [litres/min] | Pressure loss in [bar] |
|-------------|--------------|---------|--|--------------------------------|------------------------|
| Ø 1.00 mm   | 2219         | 0.45    | 0.038  | 0.58                           | 1.0                    |
| Ø 1.14 mm   | 2000         | 0.50    | 0.087  | 0.85                           | 1.0                    |
| Ø 1.20 mm   | 1830         | 0.54    | 0.052  | 0.80                           | 1.0                    |
| Ø 2.00 mm   | 990          | 1.01    | 0.097  | 2.32                           | 1.0                    |
| Ø 2.50 mm   | 766          | 1.30    | 0.172  | 3.78                           | 1.0                    |
| Ø 3.00 mm   | 577          | 1.73    | 0.083  | 4.66                           | 1.0                    |
| Ø 4.00 mm   | 409          | 2.44    | 0.187  | 8.30                           | 1.0                    |
| Ø 6.00 mm   | 237          | 4.20    | 0.416  | 11.55                          | 1.0                    |

**The values specified must be considered as approximate values.**

**The number of pulses per litre may differ depending on medium and installation.**

**We recommend to calibrate the number of pulses per litre in line with the complete installation.**

## MEASUREMENT TIPS

- Ensure that there is no fast-pulsatory movement of the media
- Ensure that there are no reverse pressure surges
- Ensure that there is no air in the system
- Keep the pressure loss as small as possible
- Note the mounting position of the flowmeter
- Min/max flow should be in the linear range of the selected flowmeter
- Clean the system at appropriate intervals
- Avoid electrical current peaks
- Incorrect cabling of power supply +, signal and ground will destroy the flowmeter
- Do not mechanically load electrical contacts
- Avoid moisture on the electrical contacts
- Avoid stray pick-up via the cable (Do not lay cables in parallel with high current loads)

# Measurement Curve FH 6.00 mm (#93A-0660/V04)

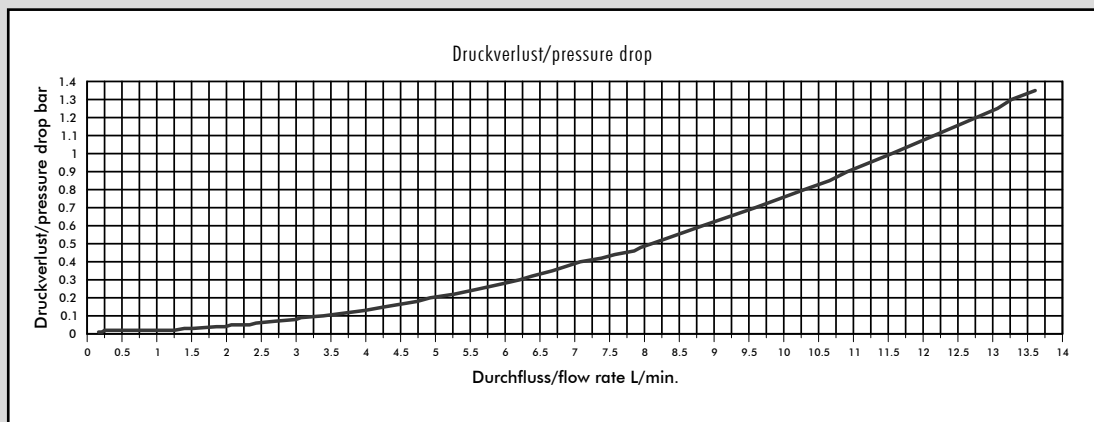
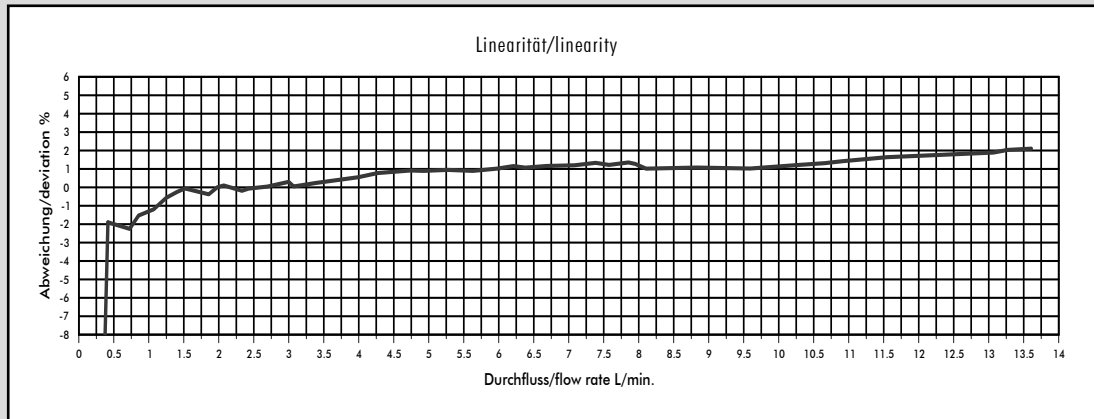

Medium: Water / max. Pressure: 3.3 bar

| Nozzle size | Pulses/litre | g/pulse | min. flow rate in [litres/min] at linear start | max. flow rate in [litres/min] | Pressure loss in [bar] |
|-------------|--------------|---------|--|--------------------------------|------------------------|
| Ø 1.00 mm   | 2219         | 0.45    | 0.038  | 0.58                           | 1.0                    |
| Ø 1.14 mm   | 2000         | 0.50    | 0.087  | 0.85                           | 1.0                    |
| Ø 1.20 mm   | 1830         | 0.54    | 0.052  | 0.80                           | 1.0                    |
| Ø 2.00 mm   | 990          | 1.01    | 0.097  | 2.32                           | 1.0                    |
| Ø 2.50 mm   | 766          | 1.30    | 0.172  | 3.78                           | 1.0                    |
| Ø 3.00 mm   | 577          | 1.73    | 0.083  | 4.66                           | 1.0                    |
| Ø 4.00 mm   | 409          | 2.44    | 0.187  | 8.30                           | 1.0                    |
| Ø 6.00 mm   | 237          | 4.20    | 0.416  | 11.55                          | 1.0                    |

## MEASUREMENT TIPS

- Ensure that there is no fast-pulsatory movement of the media
- Ensure that there are no reverse pressure surges
- Ensure that there is no air in the system
- Keep the pressure loss as small as possible
- Note the mounting position of the flowmeter
- Min/max flow should be in the linear range of the selected flowmeter
- Clean the system at appropriate intervals
- Avoid electrical current peaks
- Incorrect cabling of power supply +, signal and ground will destroy the flowmeter
- Do not mechanically load electrical contacts
- Avoid moisture on the electrical contacts
- Avoid stray pick-up via the cable (Do not lay cables in parallel with high current loads)

**The values specified must be considered as approximate values.**

**The number of pulses per litre may differ depending on medium and installation.**

**We recommend to calibrate the number of pulses per litre in line with the complete installation.**